

STAINLESS STEEL INDUSTRIAL RANGE
S80 SIZE WITH 3 PHASE MOTOR

Printed from
JABSCOshop
- a division of
CLEGHORN WARING

tel: +44(0)870 738001
fax: +44(0)870 738002
mail@jabscoshop.co.uk
www.jabscoshop.co.uk

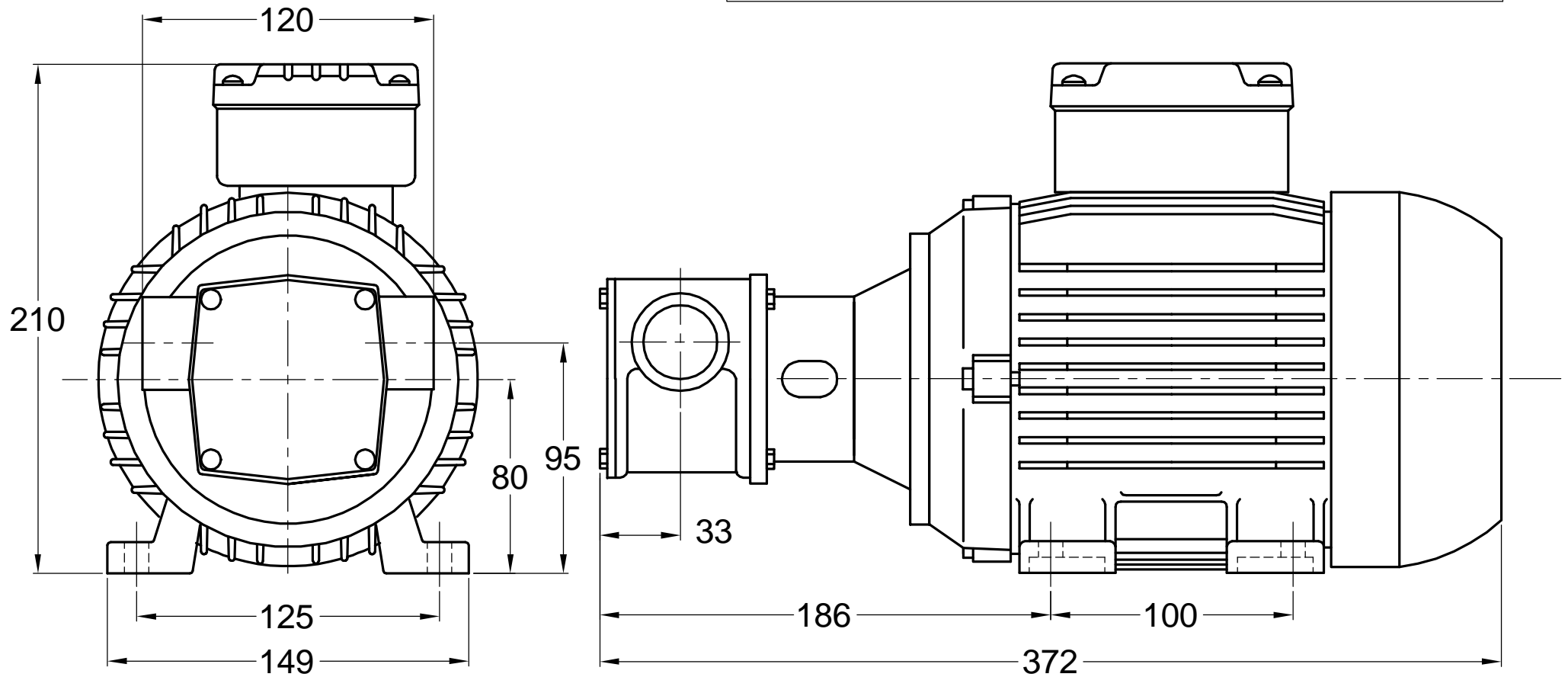

MOTOR DIMENSIONS MAY VARY ACCORDING TO MAKE AND TYPE FITTED
dimensions in mm